

LLX 200

Download and data processing
software

.....Table de matières

I – Introduction.....	2
II – Software installation.....	2
III – Driver installation.....	2
IV – Software presentation.....	4
V – LX 200 connection.....	6
VI – Open a file.....	3
VII – Software operation.....	7
VII 1 – File overview.....	7
VII 2 – Uniformity file mode.....	8
VII 3 – Temporal file mode	9
VII 4 – Mapping file mode	10
VII 5 – Spatial representation.....	11
VII5-1- Add a lighting.....	14
VII5-2- Add a workstation.....	15
VII5-3- Add an opening.....	15
VII5-4- Intervene on an element.....	15
VII5-5- Overview.....	16
VII 6 – Document settings for exportation or printing.....	17
VII 6-1 – Exportation.....	18
VII 6-2 – Printing.....	19
VII 7 – Close the file.....	19
VII 8 – Exit software.....	19

I – Introduction

Providing with **LX200** luxmeter, **LLX200** is a configuration, recovery dataprocessing software. Easy handling, it requires a small learning and allows an immediate dataprocessing.

Main functions :

- Visualization and results of different measurement modes : Uniformity - Temporal - Mapping.
- Illuminance mapping colored nances of workstations (sport facilities).
- Following temporal evolution of illuminance of a workstation or a journey
- Formatting and editing of measurement report.
- Data recovery and creation text files.
- Zoom function for more precise study of a period

II – Software installation

1. Please take necessary rights. Otherwise, contact the administrator.
2. Insert the CD-ROM. The installation program starts automatically.
Note : If setup does not start automatically, go to desktop or Windows Explorer and double-click on LLX200.
3. Follow the instructions on the screen.
Note: Depending on softwares installed on the computer (in particular NET Framework), the waiting time can be significant – Wait. For a few moment.
4. Restart computer.
It is strongly recommended that you restart the computer after installation. Remember to save and close all other programs in use before clicking Finish.
5. Software is now installed, LLX200 icon is displayed on the desktop.

III – Driver installation

1. Connect the instrument to the computer through the provided USB cable.
2. Press **INST** key then **“Screen”** key to obtain **PC –SL200** screen.
3. Press USB pictogram key 

Computer detects **SL200** instrument and proposes to install USB driver from « **Hardware Wizard** » of Windows.

3. Follow instructions, click on **“Follow”** then on **“Finish”** to validate installation

Follow usual instructions on the screen to install a driver.

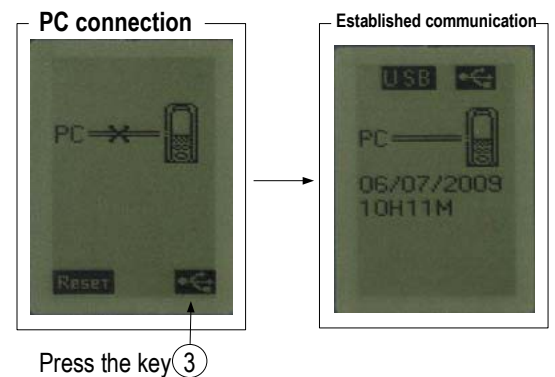

Examples: Hardware Wizard

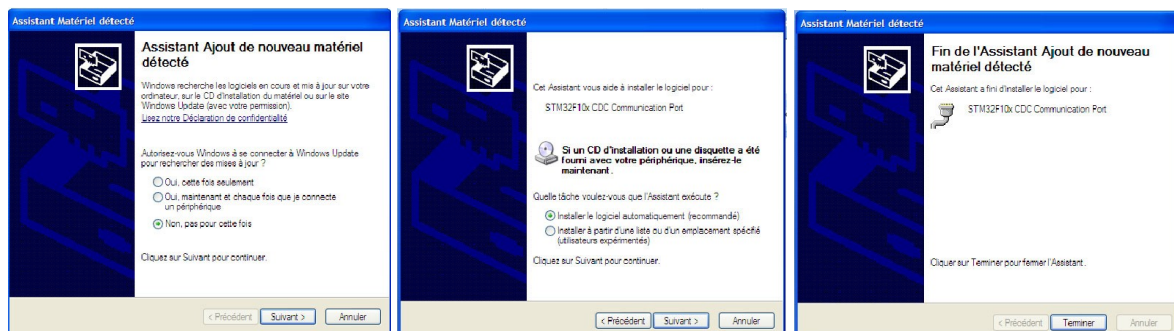

LX200 can now convey with **LLX200** software and receive files of measurement. See « **Established communication** » figure.

IV – Software presentation







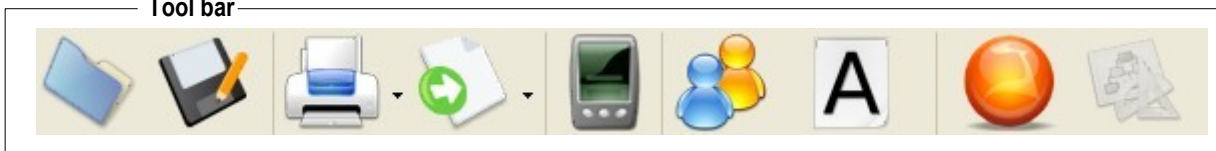

Open the software by double clicking on LLX200 icon.
The LLX200 home window is open with its toolbar :



Homepage

Tool bar



- | | | |
|--|--|--|
|  Open a file
Open |  Print a graph
Print |  Add a general comment to the statement
Global note |
|  Save a graph
Save |  Connect an instrument
LX200 | |
|  Export
Export |  Enter the name of the company
Company | |
|  Create
Creation |  Visualize
Visualization | |

Only the **Open File** and **Connect an instrument** buttons are active when you open the software.

- Meaning and function buttons in the menu bar

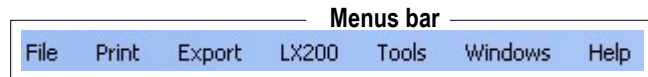

File menu

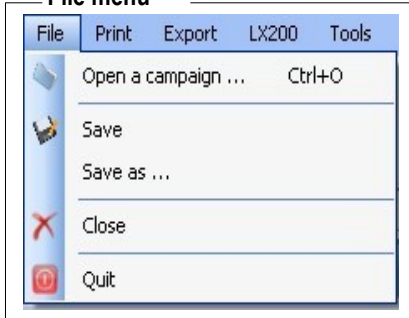

- **Open** : allows to select the campaign saved on the computer, .ldu, .ldc or .ldt. format
- **Save / Save as...** : allows to save the open file.
- **Close** : closes the current report.
- **Exit** : exits software.

Print menu



- **Table of values** : prints only the cover page and values of the current graph.
- **Report** : prints a report according user setting.

Export menu

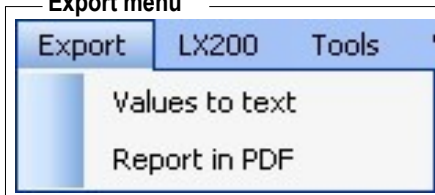

- **Values in text** : exports table values in .txt format
- **Report in pdf** : exports the report in .pdf format

LX200 menu



- **Unloading the instrument** : allows to open unloading instrument window

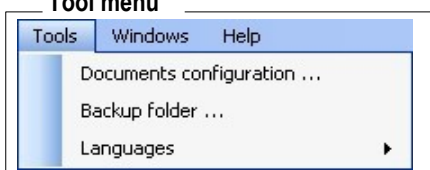

Tool menu



- **Document setting** : allows to fill in header and footer of documents for printing or exportation
- **Backup folder** : allows to modify the location where are saved the different datasets
- **Languages** : allows to change the language of the software : French or English

V – Connect LX 200 instrument



1. Connect the instrument to USB cable connected to the PC and click  icon to launch a search for identification.
2. Connection window appears. See "Connection" screen.
3. Perform the connection clicking on . If that fails, select a port (eg COM1) in the drop-down box labeled "Log on port", then click on .

If this fails, repeat the process by choosing a different port (or for advanced users search in Windows port occupied by SL200 instrument: Path : System – System Properties - Hardware - Device Manager - ports) until obtaining the connection.

4. When the connection is done, the operator can :

- **Set time of LX200** luxmeter clicking on the «pendulum» icon.

Wait for a while and then see the correction on the device.

Note : date - time information, indicated in the « Instrument Time » zone do not change, it simply indicates that modification happened at this moment.

- **Transfer data in LX200** instrument by clicking on « Save data » tab or « Save then display dataset »

The identification window of the dataset opens.

Customize the end of file names or "validate" directly.

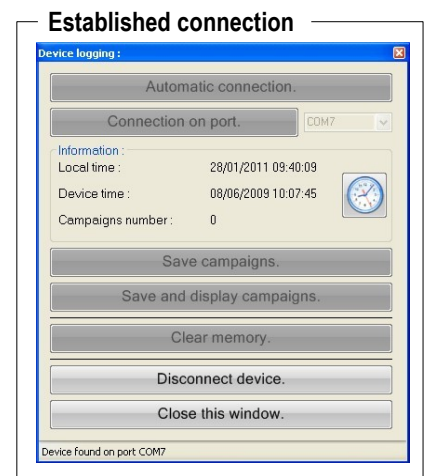

In this case the files are present for information in the directory listed as opposite :

Close the window or access directly to the file by clicking on it.

5. Once registration is completed, the operator can :

- **Erase memory instrument.**

- **Disconnect the instrument.**

- **Close the window.**

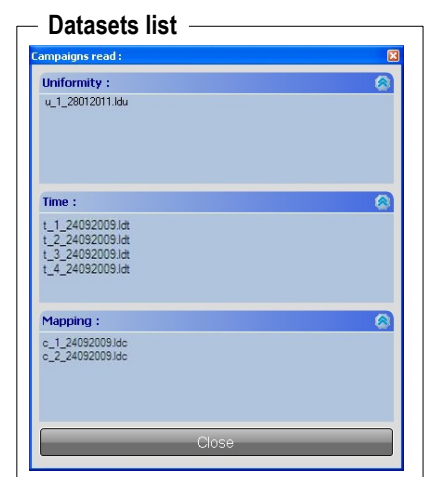

VI – Open a file

Several possibilities allow files opening :

Directly, when transferring files from the DB200 instrument to the PC:

- Double-click on the file in question.

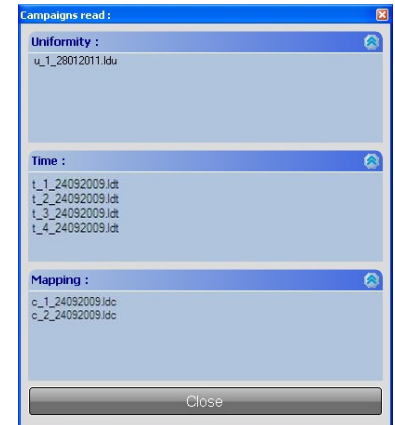

From the browser software that is accessible on the left side of the screen :

- Double-click on a file to open it.



It's possible, from the explorer, to open multiple files. They are marked by tabs at the bottom of the screen.

The choice of displaying screen or closing file is done through these tabs.

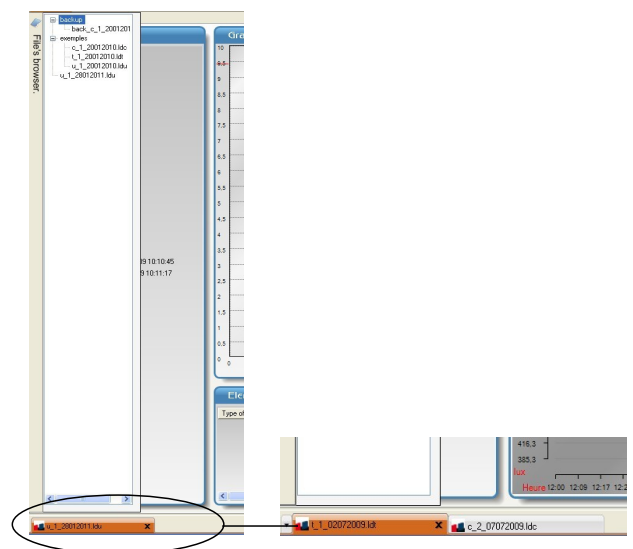

Finally, it is possible to open a file with the button "Open" or go to File> Open a campaign

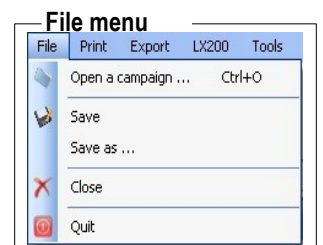

VII – Software operation

VII 1 – File overview

For the three measurement modes, **UNIFORMITY – TEMPORAL – MAPPING**, the left area on the screen shows the general results:

- Maximum illuminance
- Minimum illuminance
- Average illuminance
- Uniformity 1 : min / ave
- Uniformity 2 : min / max
- Measurement duration
- Space sizes

Special features :

UNIFORMITY :

A grid area allows to draw a spatial representation of the elements present in the measurement space:

- lighting
- Workstation
- furnitures
- openings

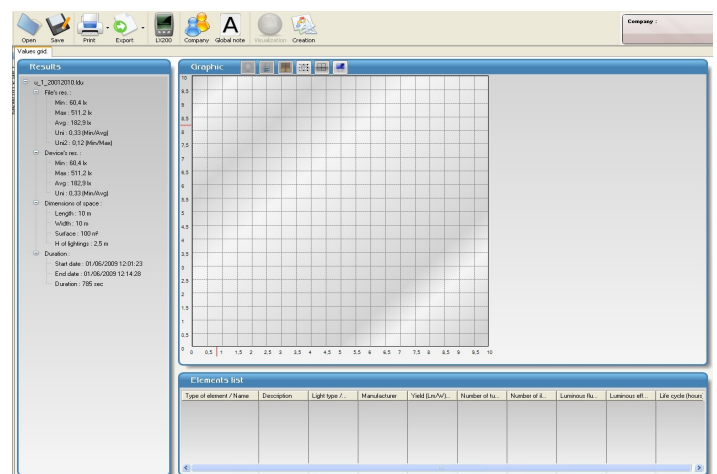

TEMPORAL :

The right area visualizes the temporal evolution of illuminance.. The grid area for the spatiale representation of elements is also available. Tab : "Spatial representation"

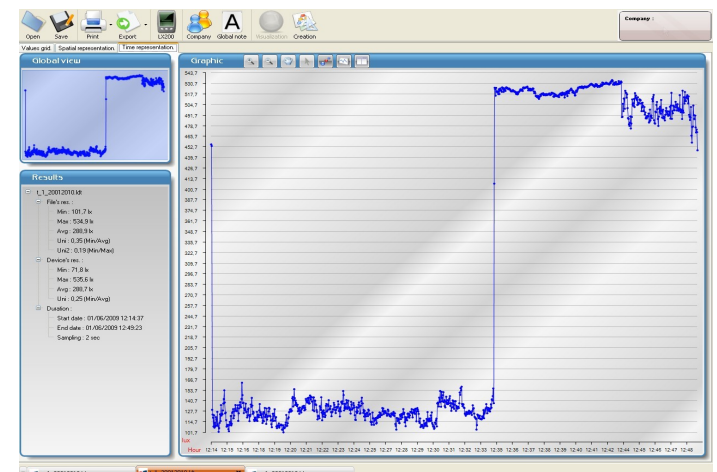

MAPPING :

A colored mapping of illuminance levels gives informations to user about illuminance dispersal in measurement space.

The spatiale representation of elements is made by superimposition on the mapping.

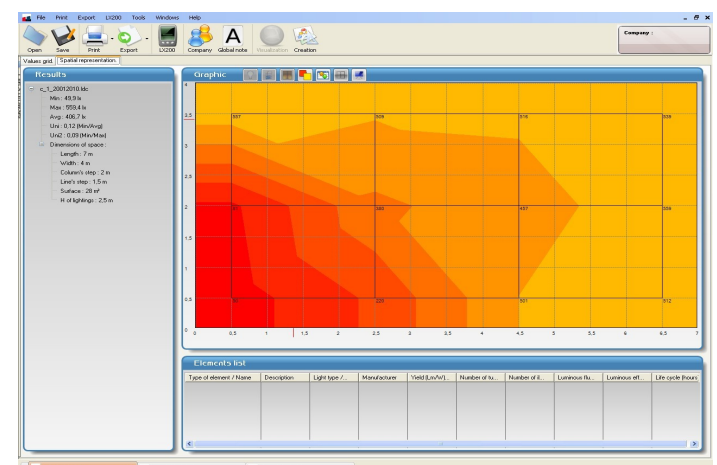

VII 2 – Uniformity mode file

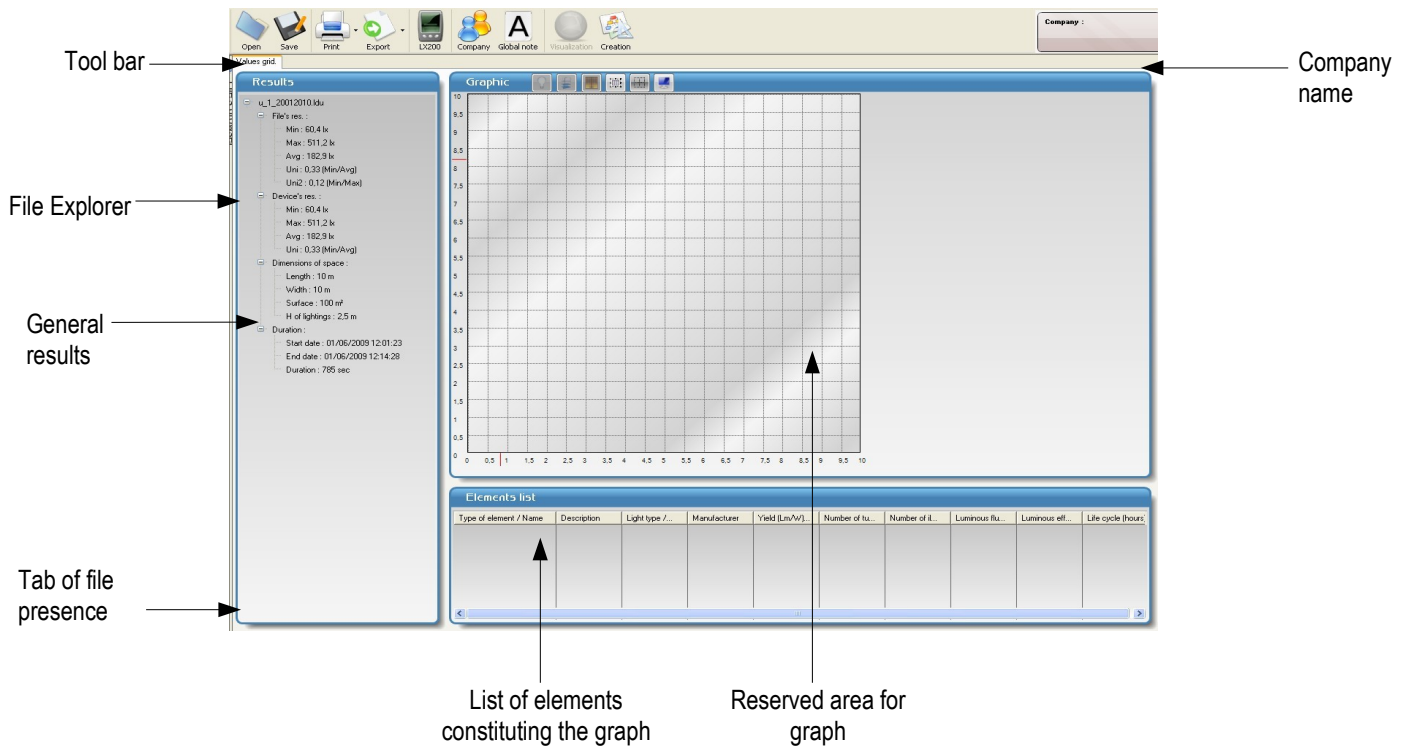

Result frame displays general informations about the totality of dataset :

- Minimum value recorded
- Maximum value recorded
- Average
- Uniformity 1 : min / average
- Uniformity 2 min / max
- Dimensions of the room / measurement space
- Dates of beginning and end of the dataset

Global results :

There are two types of results, those transferred from the LX200 and those calculated by the software. A slight difference may occur. In addition, the software calculates here the **"uniformity 2"** which is the ratio of minimum value out of maximum value. Room or space dimensions are adjustable while processing file.

Graph :

Material organization of measurement space can be represented in **"Graph"** area.. Drawn elements will be listed in **"List of elements"** area.

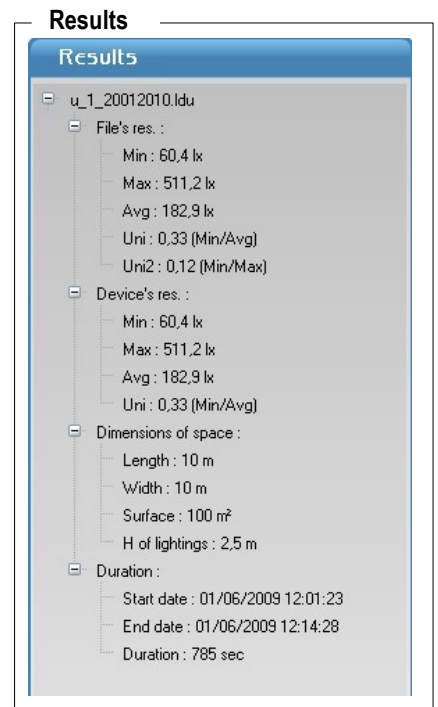

VII 3 – Temporal mode file

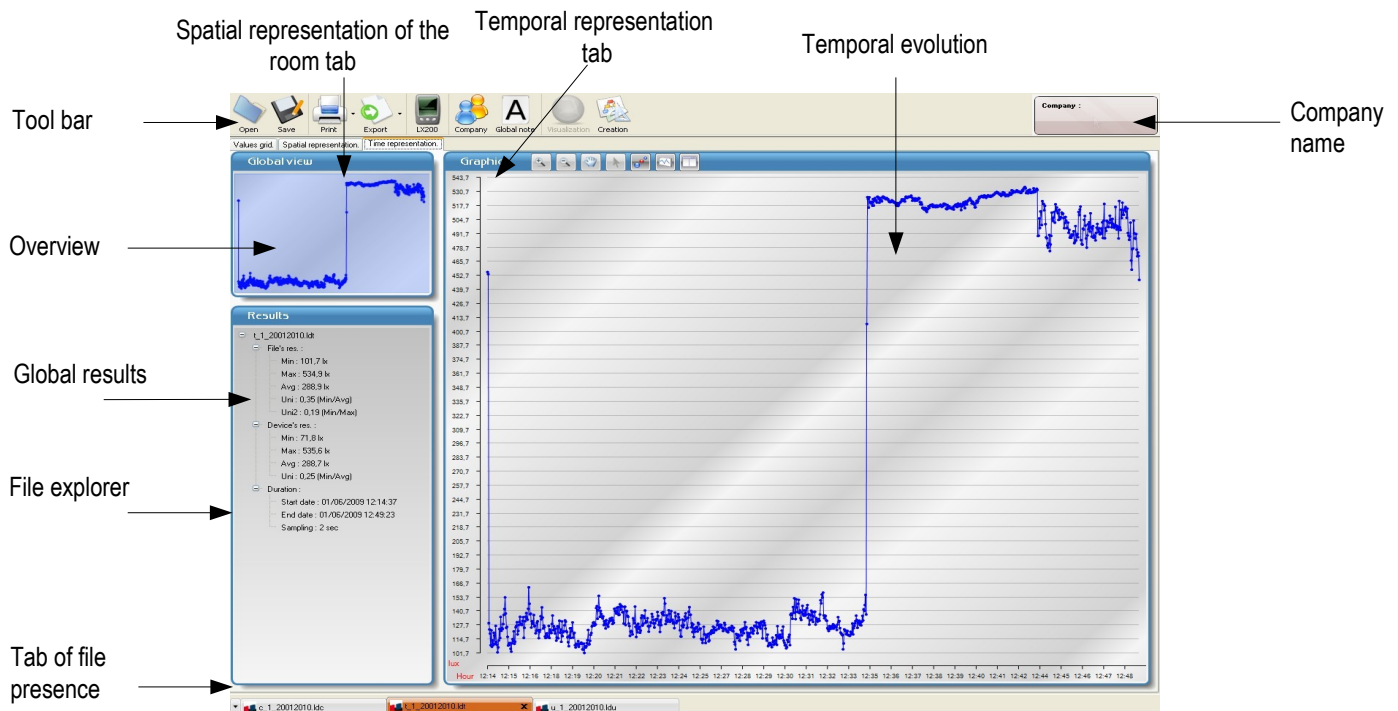

Results frame displays general informations about all the dataset :

- Minimum value recorded
- Maximum value recorded
- Average
- Uniformity 1 : min / average
- Uniformity 2 : min / max
- Room dimensions / measurement space
- Dates of beginning and end of the dataset
- Sampling rate

Global results :

There are two types of results, those transferred from the LX200 and those calculated by the software. A slight difference may occur. In addition, the software calculates here the "uniformity 2" which is the ratio of minimum value out of maximum value.

Difference from the calculation method :

The software determines the average, minimum and maximum, uniformity 1 and uniformity 2 from data stored by the LX200 with a sampling rate (variable from 1s to 600 s) whereas the instrument calculates these same parameters with a fixed sampling rate of twice by seconds. These results are transmitted th the software to be displayed. This disposition allows for a high samplig rate (eg : 1 point avery 30 s) to memorize more precisely maximum or minimum values of illuminance.

Results

Results

- [-] c_1_20012010.ldc
 - Min : 49,9 lx
 - Max : 559,4 lx
 - Avg : 406,7 lx
 - Uni : 0,12 (Min/Avg)
 - Uni2 : 0,09 (Min/Max)
 - [-] Dimensions of space :
 - Length : 7 m
 - Width : 4 m
 - Column's step : 2 m
 - Line's step : 1,5 m
 - Surface : 28 m²
 - H of lightings : 2,5 m

Graph handling :

From the following tool bar, several actions are possible in the graph :



Activate zoom function Reset the original graph Moves laterally the graph

Arrow tool allows to click an a point of the graph to display date/time and value the of point. The totality of the curve can be run with the mouse, left click hold.

Modification of the layout :
 - by deletion of point : displaying on the curve only
 - by deletion of the curve : displayng of the points only

Expanded the graph to the entire screen. Deletion of the results frame.

The software can display very specific areas of the graph :

For that, use the magnifying glass marked with a + sign :

- Click where you want the beginning of the zoom and **stay clicked**.
- Drag the mouse until the end of the zoomed period .
- Release the mouse button.
- Move laterally the graph if necessary with the hand.

The overview allows a view of all the dataset.
 The blue area indicates the displayed period.

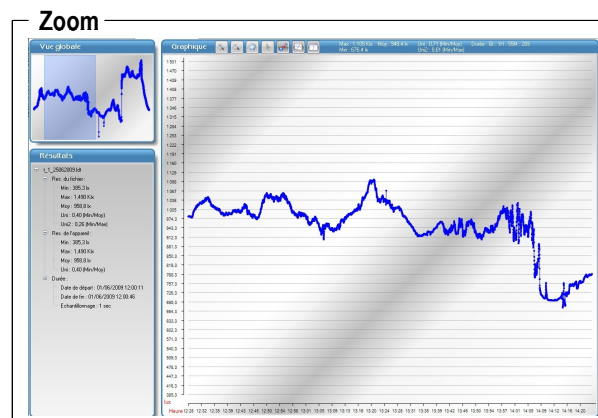

Selection results

When zooming, the graph banner displays at left of the icons results of the zoomed period :

Max : 1.105 Klx	Moy : 948.4 lx	Uni : 0,71 (Min/Moy)	Durée : 0J : 1H : 55M : 20S
Min : 676.4 lx		Uni2 : 0,61 (Min/Max)	

Tab Table of values :

The entire list of values is supplied in this table. To make changes or to comment :

- Click once on **"Value"** area to change it if it seems wrong or make a simulation.
- Click once on **"Comment"** to write a note which will appear in the pdf or txt exportations.

Table of values

Colonne	Valeur	Commentaires
01/06/2009 13:32:11	946.8	
01/06/2009 13:32:12	946.7	
01/06/2009 13:32:13	946.7	
01/06/2009 13:32:14	946.4	
01/06/2009 13:32:15	945.3	
01/06/2009 13:32:16	945.2	
01/06/2009 13:32:17	945.2	
01/06/2009 13:32:18	945.6	
01/06/2009 13:32:19	945.5	
01/06/2009 13:32:20	945.2	
01/06/2009 13:32:21	944.9	
01/06/2009 13:32:22	945.2	
01/06/2009 13:32:23	945.2	
01/06/2009 13:32:24	945.2	
01/06/2009 13:32:25	944.6	
01/06/2009 13:32:26	944.1	
01/06/2009 13:32:27	945.0	
01/06/2009 13:32:28	945.3	
01/06/2009 13:32:29	945.9	
01/06/2009 13:32:30	945.9	
01/06/2009 13:32:31	945.3	
01/06/2009 13:32:32	945.1	
01/06/2009 13:32:33	943.7	
01/06/2009 13:32:34	942.4	
01/06/2009 13:32:35	940.8	
01/06/2009 13:32:36	939.3	
01/06/2009 13:32:37	939.0	

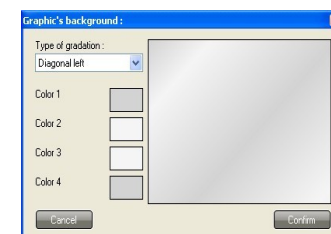

A double click on the graph displays the configuration window of background colour of the gap.

VII 4 – Mapping mode file

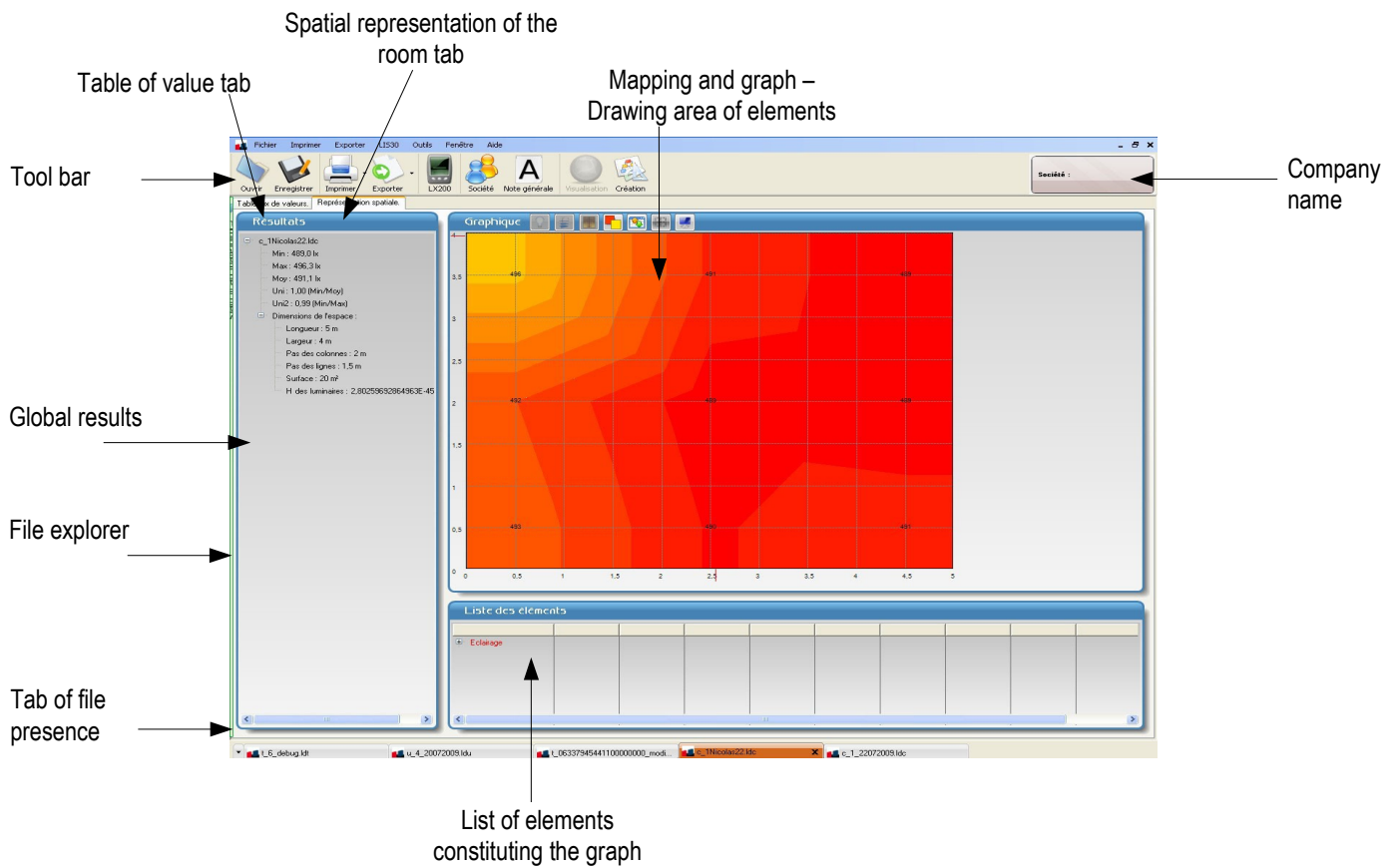

Results frame displays general informations about all the dataset :

- Minimum value recorded
- Maximum value recorded
- Average
- Uniformity 1 : min / average
- Uniformity 2 : min / max
- Room dimensions / space measurement
- Dimensions of the measurement room provided by **LX200**

Results





Results

- [-] c_1_20012010.Idc
 - Min : 49,9 lx
 - Max : 559,4 lx
 - Avg : 406,7 lx
 - Uni : 0,12 (Min/Avg)
 - Uni2 : 0,09 (Min/Max)
 - [-] Dimensions of space :
 - Length : 7 m
 - Width : 4 m
 - Column's step : 2 m
 - Line's step : 1,5 m
 - Surface : 28 m²
 - H of lightings : 2,5 m

Graph creation :

From the following tool bar, several actions are possible on the graph :



-  Allows an direction choice of the mapping among 4
-  Access to mapping settings.
-  Withdraw or not the grid locator mapping
-  Delete some of elements on the graph

Mapping direction :



To represent correctly on the screen the direction of the room or the measurement space, it is necessary to give information about **the starting point of measurement reading and the direction of travel** in accordance with the procedure described in the instructions of the LX200.

•Click on the corresponding arrow.

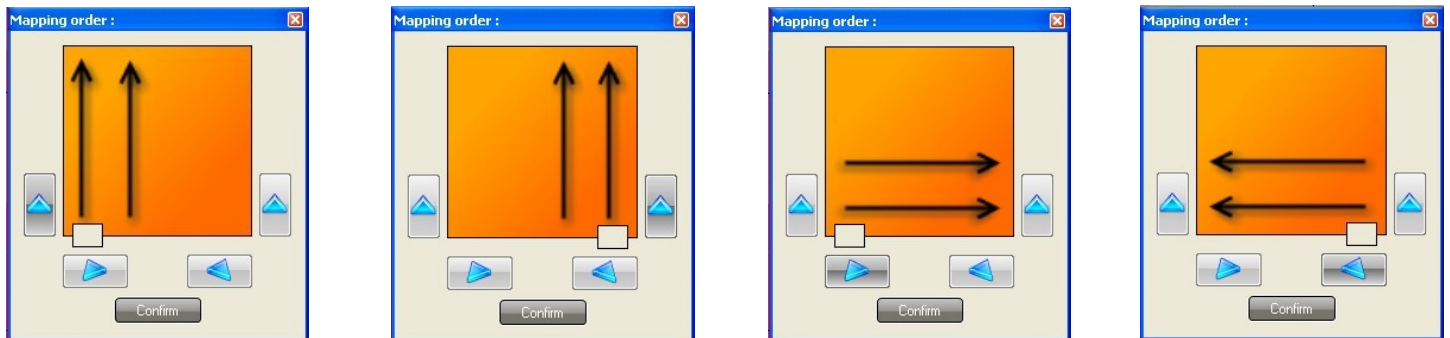

Table of values tab :

The entire list of values is provided in this tab. It is completed by the list of « **no value** » proposed by the software which appear underlined..

- Click once on the « **Value** » or « **no value** » area modify it if it seems wrong or to make a simulation.
- Click once on the « **Comment** » area to write a note which will appear in pdf or txt exportations.

Table of values

Values grid				
Column	Point	Value (x)	Comments	Non value (x)
1	1	49,87		
1	2	80,85		
1	3	556,9		
2	1	219,7		
2	2	380		
2	3	508,6		
3	1	500,7		
3	2	457,2		
3	3	515,8		
4	1	512,2		
4	2	553,4		
4	3	533,1		

Mapping settings :



From the icon  :

- Fill in the height of the room lighting
- Choose the mode of graph representation, "Shaded" or "Customized levels".

"Shaded" mode

The principle resumes this one of curves of the same luminous intensity or « isolux ». It is extended to a more visual representation of areas with variable colouring according illuminance levels.

The software always proposes an adapted step to the dynamic of illuminance levels

- Click in the "Step" area to modify the value
- Click on the coloured squares and choose the colours

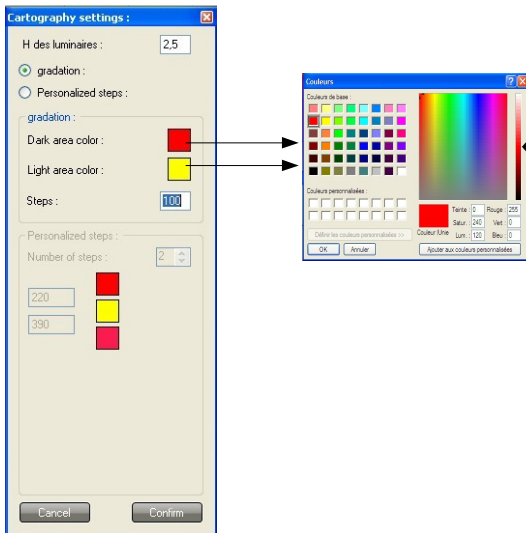
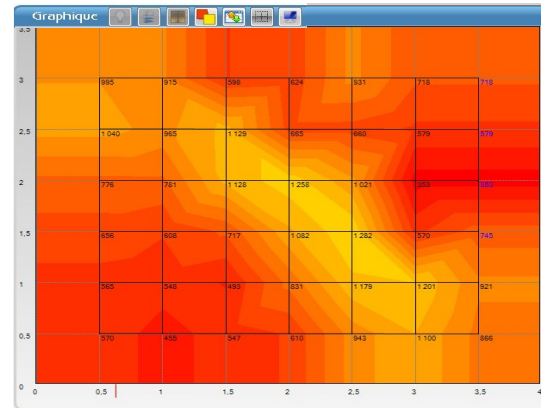

"Customized levels" mode

This mode allows the identification of areas with controlled illuminance. Colouring is about limit levels of illuminance. The software always proposes 2 areas according levels.

To modify or extend to several areas (3 for example) :

- Modify the "Level number" .
- Choose the limit values of color separation
- Choose the colours clicking on coloured squares

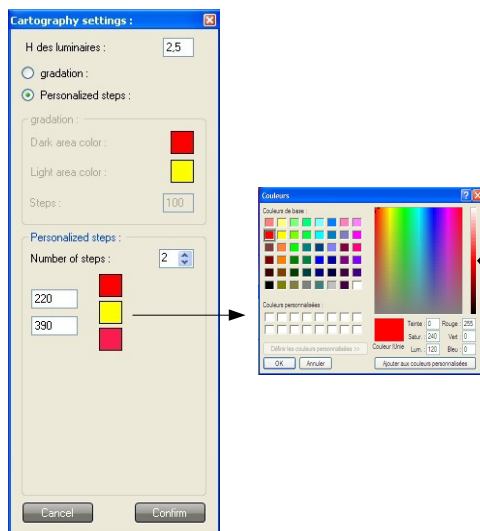
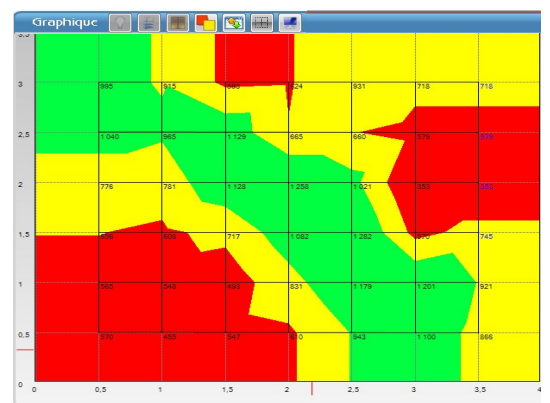

Graph customization :



- Click on icon 
- Choose the elements that must appear on the graph

Customization



VII 5 – Spatial representation

For the three measurement modes, **UNIFORMITY – TEMPORAL – MAPPING**, it is possible to combine to results a graph representation of the space. So we can insert in the grid area elements such as :

- Lightings
- Workstations
- Openings
- Partitions
- An area to optimize the geometrical representation of the room

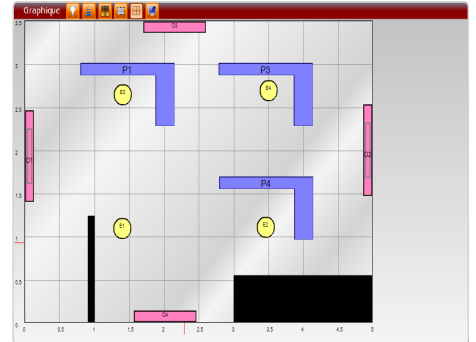

Proceed as follow :

- Click on "**Creation**" button  of the general tool bar. Buttons    of the graph tool bar become active

 Allows to add a lighting system

 Allow to add an opening

 Allows to add a workstation



VII5-1 Add a lighting

- Click on "**Add a lighting**" button .
- Fill in the different fields in "**Display**", "**Luminosity**" and "**Tubes**" then validate.

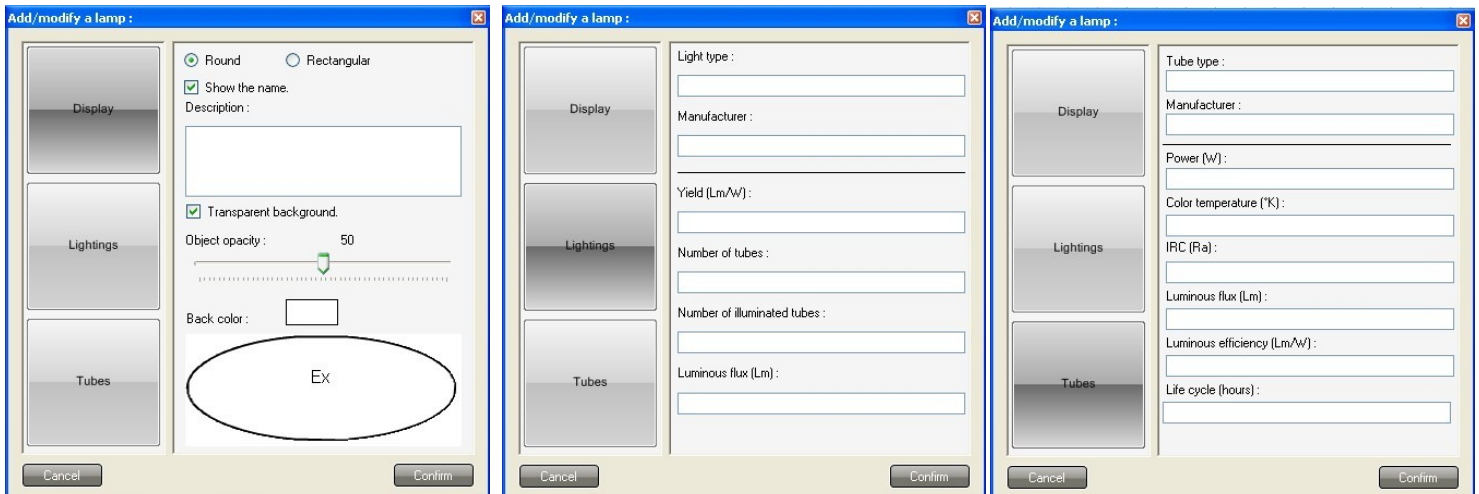

After validating the informations, the lighting is place at the top left of spatial representation.

With left click of the mouse, it's possible to :

- adjust its size.
- Move it and place it correctly on the grid.

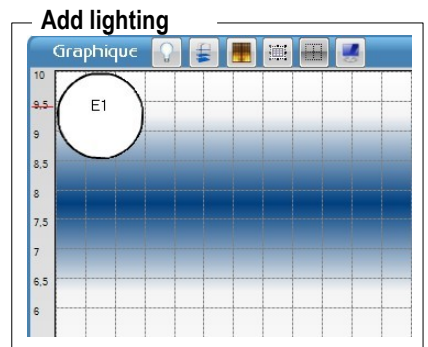

VII5-2 Add a workstation

- Click on button "Add a workstation" button  .

- Choose : rectangular or angular.
- Fill description field.
- Choose workstation field.
- Define a colour.

Note : tick preferably "Transparent background" to be able to read by transparency illuminance values present in **mapping** mode.

After validating, the workstation is placed at the top left of spatial representation. With left click of the mouse, it's possible to :

- Adjust its size.
- Move it and place it correctly on the grid.

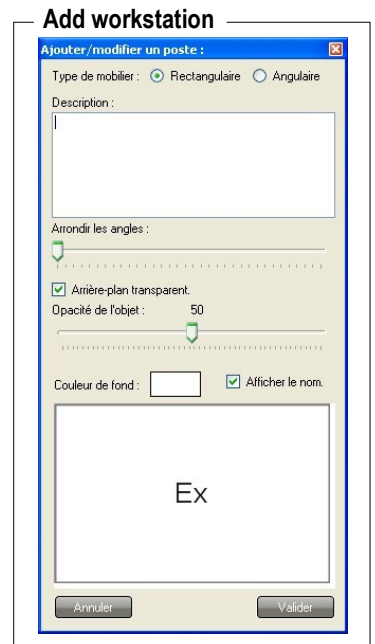

VII5-3 Add an opening

- Click on the button "Add an opening"  .

- Choose : door, wall or window.
- Tick or untick "Display a name"
- Fill in description field
- Define a colour

Note : tick preferably "Transparent background" to be able to read by transparency illuminance values present in **mapping** mode.

After validating, the object is placed at the top left of spatial representation. With left click of the mouse, it's possible to :

- Adjust its size.
- Move it and place it correctly on the grid.

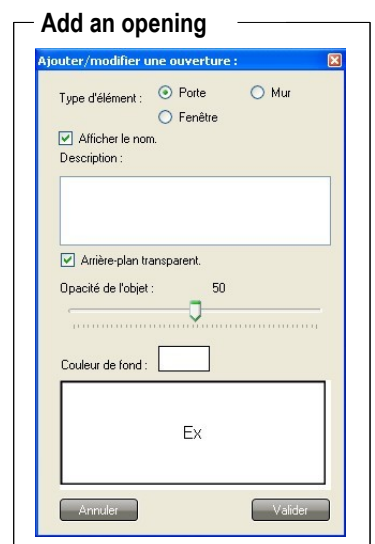

VII5-4 Intervene on an element

It's possible to modify, copy, delete an element. To do that :

- Select the element clicking with left button of the mouse..
- Click with right button of the mouse : the menu appears
- Choose the intervention in the menu

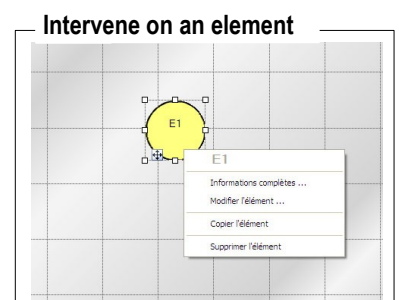

VII5-5 Overview

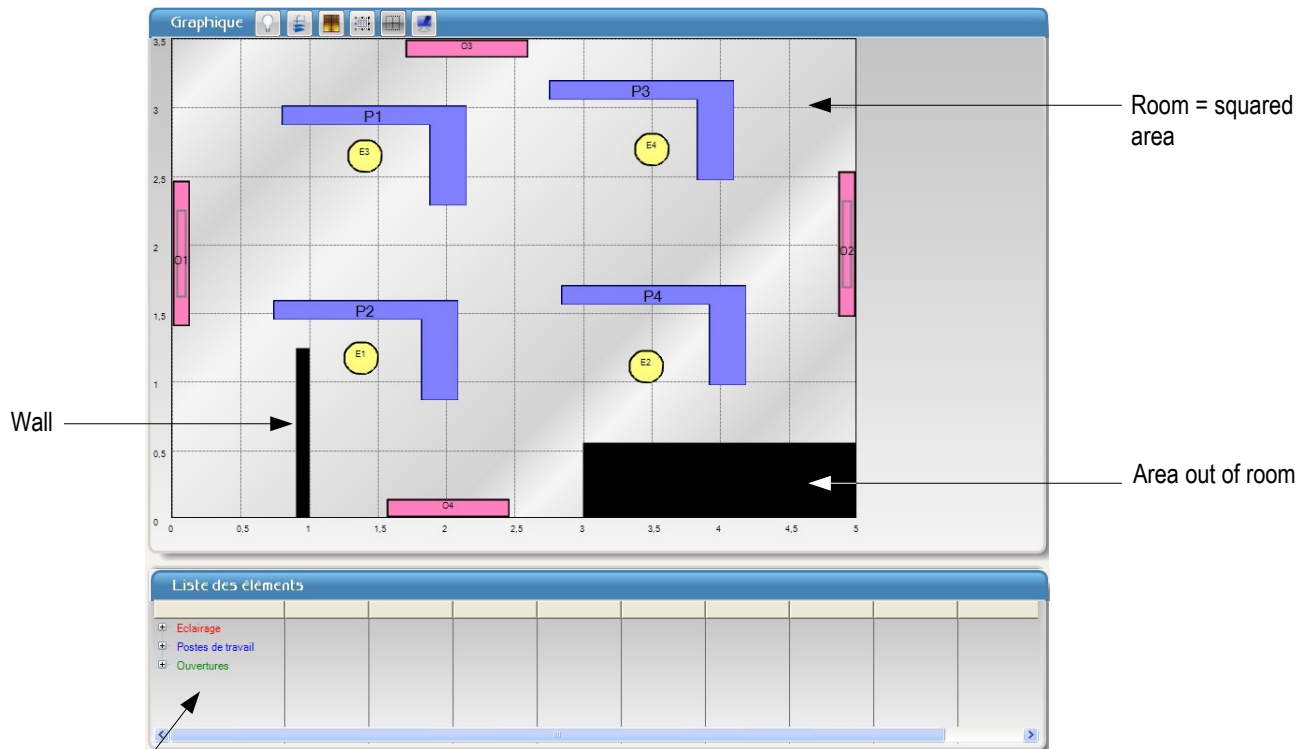

List of elements : as the implementation of elements, the list under the graph is completed, it aggregates information included during the creation of each element.

Do not forget to save the modified file with a different name from the original file.

To save, click on "File" then "Save as" or click on the button



It's possible to customize the graph and delete some elements, for example the grid or the openings.

To do that, activate the button



List of elements

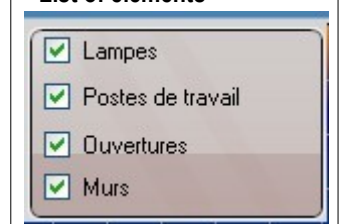

VII 6 – Documents setting for exportation or printing

LLX200 software allows to export or print results as report dataset. Before export or print the reports, some settings have to be set. On this report dataset, it's possible to fill in company name, its address, any comments,... Here's how :

- Click on **"Tool"** then **"Documents setting"**, the following window opens :
- Fill in the fields.

- Click on **"Company"** button, the following window opens :
- Fill in the fields.

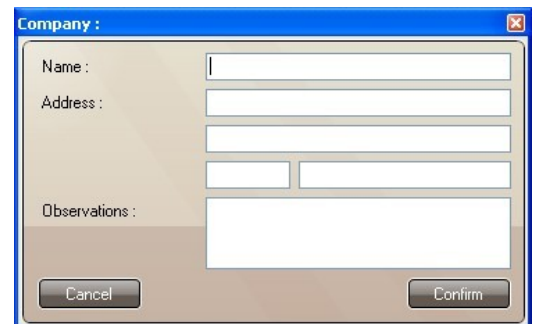
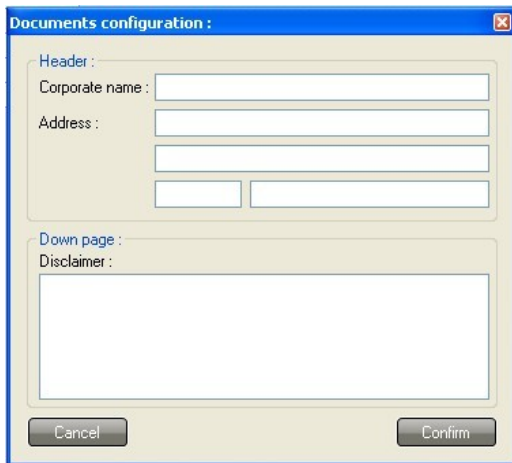

Report example

Informations about the company in which measurements have been made appear on the exportation or printing document

Comments : eg : measurement conditions

KIMO	e-1.20012010.1ab		← Header
LLX200	Campaign's report		
28/01/2011			
Company / Organism :			
Device :			
Type : LX200			
Serial number / Instrument :		Cell :	
Calibration last date :		Certification number :	
Parameters :			
Reference :			
Type : Mapping			
Results :			
File's res. :			
Minimum : 49,9 lx			
Maximum : 559,4 lx			
Average : 406,70 lx			
Uniformity : 0,12 (min/moy)			
Uniformity2 : 0,09 (min/max)			
Comment :			
Observations :			
Disclaimer :			
			← Footer

To add a general comment, click on **"General note"** button and fill in general comment frame.

VII 6-2 – Printing

Printing concerns :

- Table of values
- A measurement report of all or a part of components of the processing original file.

Print the table of values or the report :

- Click on the arrow of the printing button  and select the mode "Table of values" or "Report".
- in "Report" mode choose the desired setting in the frame "Choose a printing".
- Validate and launch printing from "Printing" frame.
- **The preview is displayed for control :**
- Launch printing clicking on "Printer" icon of the preview



VII 7 – Close the file

To close the file :

- Click on **File**.
- Click on **Close the file**.

Close the file

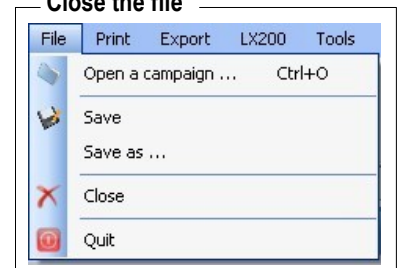

When the file is closed, application back to homepage of the software.

VII 8 – Exit software

To exit software :

- Click on **File**.
- Click on **Exit**.

Exit software

